

## VivaTech TeraHertz SAS Nice, France

*VivaTech TeraHertz designs and manufactures custom solutions for TeraHertz (THz) components, modules and systems operating in the frequency range 50-1100 GHz.*

*VivaTech TeraHertz offers customized components, modules or systems for research and development applications in the TeraHertz and Sub-TeraHertz spectrum.*

*These include broadband frequency converters, extenders for microwave sources and Vector Network Analyzers (VNA). Applications include high data rate communications, automotive radar, plasma diagnostics amongst others.*

*This **short form catalogue** offers examples of capability, based on decades of experience in mm-wave and THz development.*

*VivaTech TeraHertz also supports the calibration and repair of mm-wave and THz products from other manufacturers.*

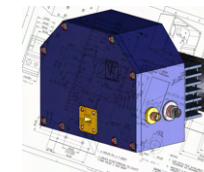
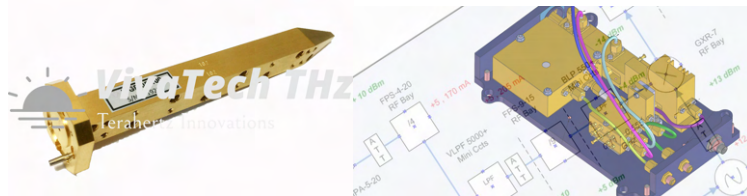
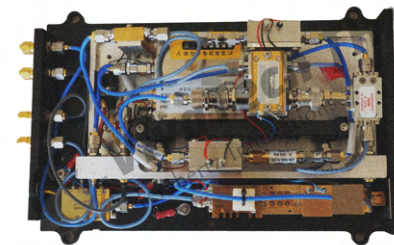

## Contents Page 1 of 2

### 5G/6G Up Down Converters 75 - 350 GHz

92-110 GHz Up-converters and Downconverters for 5G/6G Applications .....1

220-260 GHz Downconverters for 5G/6G Applications.....2,3

220-260 GHz Up-converters for 5G/6G Applications .....4

### Fullband 75-500 GHz Up /Down Converter Pairs

75-220 GHz Linear Up-converters and Downconverters... .....5,6

170-500 GHz Linear Up-converters and Downconverters... .....7,8

### 670 GHz Transmitter/Receiver Pair

670 GHz Linear Up-converter and Downconverter for automotive radar applications.....9

### Multifunction Converter Modules 110-330 GHz

Converters for spectrum analysers, noise figure testing and block upconverter function .....10,11

### Active Multipliers / Source Modules

Source Extender Modules .....12

### Amplifiers – Low Noise 50 - 350 GHz

Low Noise Amplifiers 50-350 GHz .....13

### Mixers – 50 - 500 GHz

Balanced, Fundamental .....14

Subharmonic, n = 2 .....15

Harmonic.....16

### Mixer Preamplifiers – 183 GHz Broadband Radiometer Module

Low noise broadband integrated mixer-amplifier module with state-of-art performance .....17

## Contents Page 2 of 2

### Waveguide Interconnections

Precision Waveguide Straight Sections .....	18
Precision Waveguide Transitions .....	19
Precision Waveguide Bends and Twists.....	20

### Waveguide Couplers

Waveguide Directional Couplers 50-500 GHz.....	21
------------------------------------------------	----

### Waveguide Isolators

Waveguide Isolators 50-400 GHz.....	22
-------------------------------------	----

### Waveguide Filters

Custom Filters Lowpass / Bandpass.....	23
Custom Filters Highpass.....	24

### Antennas

Waveguide Pyramidal Horns .....	25
Waveguide Diagonal Horns .....	26
Waveguide Lens Horns.....	27

### Near Field Probes for Antenna Testing

Millimeter/THz Near Feld Probes .....	28
---------------------------------------	----

### Millimeter Wave Noise Sources

Millimeter Noise Sources 40-170 GHz .....	29
-------------------------------------------	----

### Noise Figure Downconverters \* See also Multifunction Converter Modules pgs.10-11

Noise Figure Downconverters 40-170 GHz.....	30
---------------------------------------------	----

### Cryogenic Primary Noise Standard

Cryogenic Primary Noise Standard 18-500 GHz.....	31
--------------------------------------------------	----

## 92-110 GHz SSB Up/Down Converters

### General Features

- 6G broadband communications and antenna test range applications
- Extend signal generators/spectrum analyzers or VNA's to mm-wave and THz
- Coverage 75 - 670 GHz in standard and custom bands
- Extend VNA's without direct LO/IF access
- Synchronous frequency and swept operation
- Single Sideband (SSB) versions eliminate image response
- Rugged screened enclosures machined from solid



Fig 1 92-110 GHz SSB Upconverter / Downconverter Pair

### Specifications

Model	THZBUC-10NB-SSB**	THZBDC-10NB-SSB**
Input/Output Frequency (GHz)	92-110	92-110
Input RF Frequency (GHz)	2-20	2-20
Input LO Range (GHz)	Internal	Internal
Upconverter Power Output (dBm)	<b>+18 typical</b>	-
Upconverter Gain (dB)	> 20 dB typical	-
Downconverter SSB Noise Figure (dB)	-	<b>&lt; 7.0 typical</b>
Downconverter Conversion Gain (dB)	-	20.0 typical
LO /IF Connectors	SMA/K (F)	SMA/K (F)
RF Connector	WR10 ; UG387/U-M	WR10 ; UG387/U-M
Dimensions (mm)	145 x 230 x 60	100 x 200 x60
DC Power (external PSU)	15V 2A	15V 1.5A

### Notes

1. \*\*Compatible with Signal Generators, Desktop & Portable VNAs up to 40 GHz
2. Full band converters are available with external LO +10 to + 13 dBm
3. Upconverter / Downconverter pair measures S21 (transmission) phase and amplitude
4. Reference oscillator input 10 MHz or 100 MHz for synchronization to external equipment
5. Other frequency ranges up to 1 THz on request
6. **How to make a request:** choose Model, or state frequency range, required interfaces, email to: [sales@vivatechthz.com](mailto:sales@vivatechthz.com)

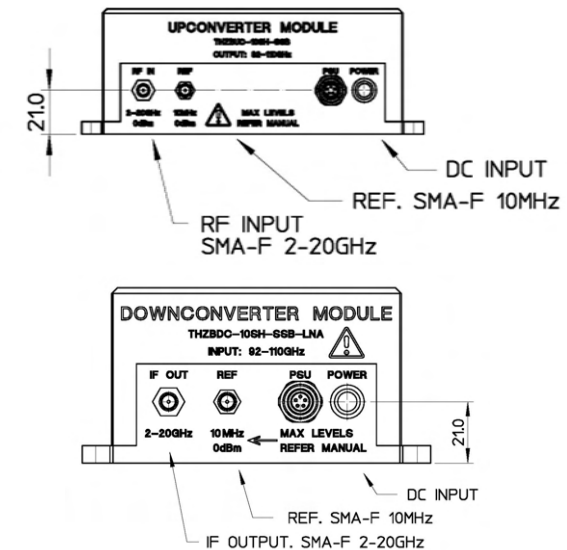

Fig 2 Converter Interfaces

## 220-260 GHz Down Converters for 5G/6G Applications

### General Features

- 5G/6G broadband communications and antenna test range applications
- State- of- art noise figure
- Extend signal generators/spectrum analyzers or VNA's to mm-wave and THz
- Coverage 75 - 670 GHz in standard and custom bands
- Extend VNA's without direct LO/IF access
- Synchronous frequency and swept operation with VNA
- Single Sideband (SSB) versions eliminate image response (option)
- Rugged screened enclosures machined from solid

### Specifications

Model	THZBDC-03NB**	THZBDC-03NB-LNA**
Input Frequency (GHz)	220-260	220-260
Output RF Frequency (GHz)	0.1-20	0.1-20
Input LO (GHz)	Internal, 10.0	Internal, 10.0
Upconverter Power Output (dBm)	N/A	N/A
Upconverter Gain (dB)	N/A	N/A
Downconverter DSB Noise Figure (dB)	< 18.0 typical	< 10.0 typical w/LNA
Downconverter Conversion Gain (dB)	10 -15 typical	25 typical
Input 1 dB GCP (dBm)	-10 typical	-30 typical
Ext LO / IF Connectors	SMA/K (F)	SMA/K (F)
RF Input Connector	WR03; UG387/U-M	WR03; UG387/U-M
Dimensions (mm)	145 x 230 x 60	145 x 230 x 60
AC Power Supply (external PSU)	110-240 VAC	110-240 VAC



Fig 1: 220-260 GHz Downconverter Model THZBDC-03



Fig 2: 220-260 GHz Downconverter Rear

## 220-260 GHz Down Converters for 5G/6G cont'd

### Notes

1. \*\*Compatible with Signal Generators and VNAs up to 40 GHz, eg. Keysight / R & S etc.
2. Internal or external Local Oscillator, standard level +10 to +13 dBm
3. Downconverter is shown, a compatible up-converter is available
4. Reference oscillator input 10 MHz as standard for synchronization to external equipment
5. Other frequency ranges up to 1 THz on request
6. Dimensions, specifications and photos are subject to change
7. **How to make a request:** choose Model, or state frequency range, required interfaces, email to: [sales@vivatechthz.com](mailto:sales@vivatechthz.com)

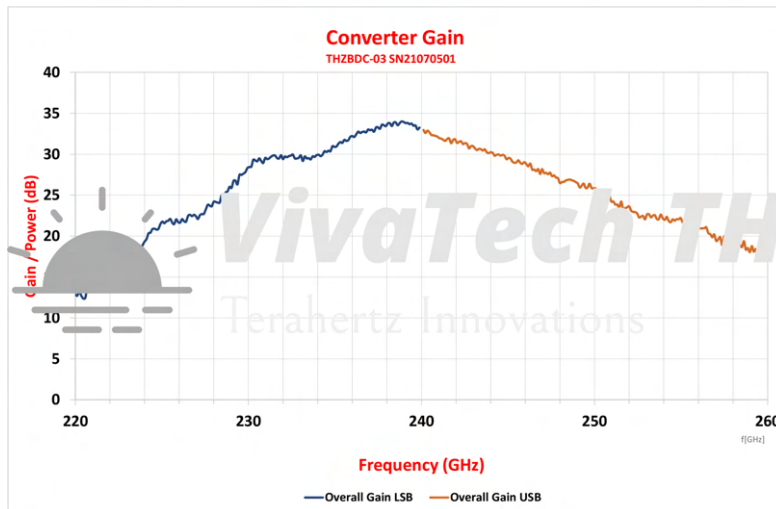

Fig 3 220-260 GHz Downconverter Gain

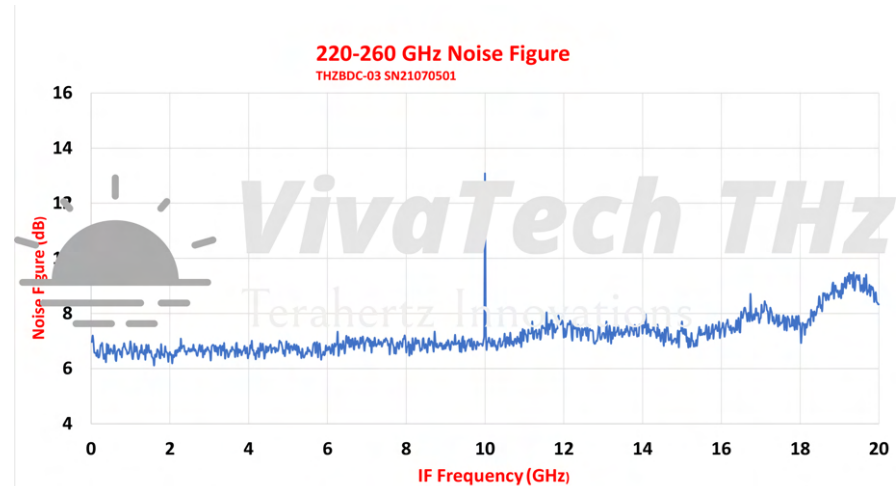

Fig 4 220-260 GHz Downconverter Noise Figure

## 220-260 GHz Up Converters for 5G/6G

### General Features

- 5G/6G broadband communications and antenna test range applications
- Extend signal generators/spectrum analyzers or VNA's to mm-wave and THz
- Coverage 75 - 670 GHz in standard and custom bands
- Extend VNA's without direct LO/IF access
- Synchronous frequency and swept operation with VNA
- Single Sideband (SSB) versions eliminate image response (option)
- Rugged screened enclosures machined from solid

### Specifications

Model	THZBUC-03NB**	THZBUC-03NB-PA**
Output Frequency (GHz)	220-260	220-260
Input RF Frequency (GHz)	0.1-20	0.1-20
Input LO (GHz)	Internal, 10.00	Internal, 10.00
Upconverter Power Output (dBm)	-25 to -35	-5 to -10
Upconverter Conversion Loss (dB)	25 - 35	10 - 15
Downconverter DSB Noise Figure (dB)	N/A	N/A
Downconverter Conversion Gain (dB)	N/A	N/A
Input 1 dB GCP (dBm)	-10 typical	-10 typical
Ext LO / IF Connectors	SMA/K (F)	SMA/K (F)
RF Input Connector	WR03; UG387/U-M	WR03; UG387/U-M
Dimensions (mm)	145 x 230 x 60	145 x 230 x 60
AC Power Supply (external PSU)	110-240 VAC	110-240 VAC



Figure 1 THZBUC-03NB Upconverter

### Notes

1. \*\*Compatible with arbitrary waveform generators, signal generators, VNAs up to 40 GHz, eg. Keysight / R & S etc.
2. Internal or external Local Oscillator, standard level +10 to + 13 dBm
3. Upconverter / Downconverter pair measures S21 amplitude & phase
4. Reference oscillator input 10 MHz for synchronization
4. Other frequency ranges up to 1 THz on request
5. Dimensions, specifications and photos are subject to change
6. **How to make a request:** choose Model, or state frequency range, required interfaces, email to: [sales@vivatechthz.com](mailto:sales@vivatechthz.com)

## Fullband 75-500 GHz Up/Downconverters

### General Features

- Full band coverage from 75 – 500 GHz
- Broadband output power
- Upconverter / Downconverter Pairs with Linear Operation
- High sensitivity receivers
- 5G/6G communications research



Fig 1 110-330 GHz Upconverter



Fig 2 110-330 GHz Downconverter

### Specifications (75-220 GHz)

Model	THZBUC-10	THZBDC-10	THZBUC-06	THZBDC-06	THZBUC-05	THZBDC-05
<b>FUNCTION</b>	<b>UPCONVERTER</b>	<b>DOWNCONVERTER</b>	<b>UPCONVERTER</b>	<b>DOWNCONVERTER</b>	<b>UPCONVERTER</b>	<b>DOWNCONVERTER</b>
<b>RF Frequency (GHz)</b>	75-110	75-110	110-170	110-170	140-220	140-220
<b>RF Power Output (dBm)</b>	+18 typical	-	-15 typical	-	-15 typical	-
<b>RF Input Maximum (dBm)</b>	-	-20	-	-15	-	-15
<b>IF Input Frequency (GHz)</b>	0.1-18	-	0.1-20	-	0.1-20	-
<b>IF Input at saturation (dBm)</b>	10	-	-5	-	-5	-
<b>IF Output Frequency (GHz)</b>	-	0.1-18	-	0.1-20	-	0.1-20
<b>Conversion Gain, (dB)</b>	20 typical	20 typical	20 typical	20 typical	20.0 typical	20.0 typical
<b>Noise Figure (dB), DSB typical</b>	-	< 7.5	-	10-12	-	10-12
<b>LO Frequency (GHz) @ +13 dBm</b>	12.5-18.33	12.5-18.33	9.17-14.17	9.17-14.17	11.66-18.33	11.66-18.3
<b>LO /IF Connector</b>	2 X SMA/K (F)	2 X SMA/K (F)	2 X SMA/K (F)	2 X SMA/K (F)	2 X SMA/K (F)	2 X SMA/K (F)
<b>RF Connector</b>	WR10, UG387/U-M	WR10, UG387/U-M	WR06, UG387/U-M	WR06, UG387/U-M	WR05, UG387/U-M	WR05, UG387/U-M

### Notes

1. Module dimensions 70 x 100 x 180 mm (3 Channel THZBUC and THZBDC) excluding fixings (TBC)
2. Test data: Upconverter - power output and spectrum, downconverter - gain and noise figure
3. DSB operation; SSB options to order
4. Option: internal oscillator with 10 MHz or 100 MHz synchronization
5. Optional: RF input LNA and output PA to customer specifications; consult factory
6. **How to make a request:** choose Model, or state full specifications, required interfaces, email to: [sales@vivatechthz.com](mailto:sales@vivatechthz.com)



## Test Data Models THZBUC-06/ THZBDC-06

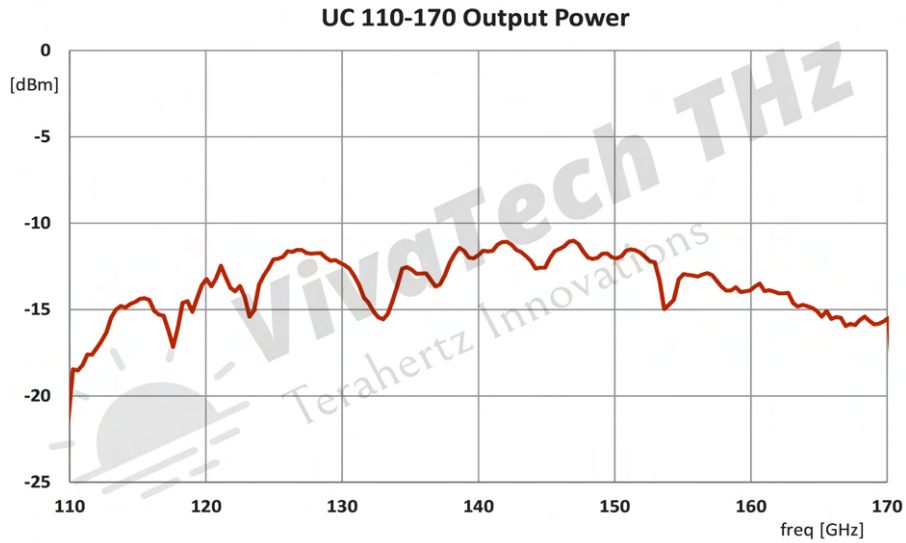

Fig 3 110-170 GHz Upconverter Output Power

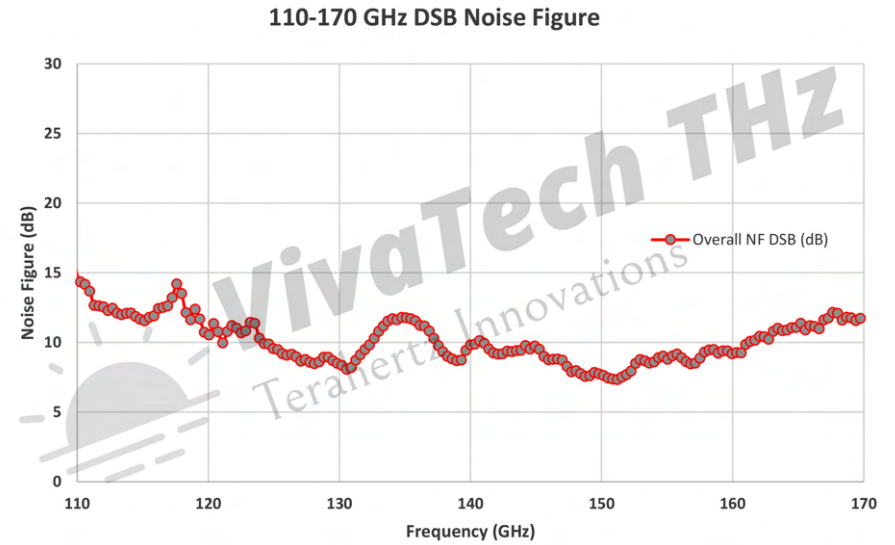

Fig 4 110-170 GHz Downconverter Noise Figure

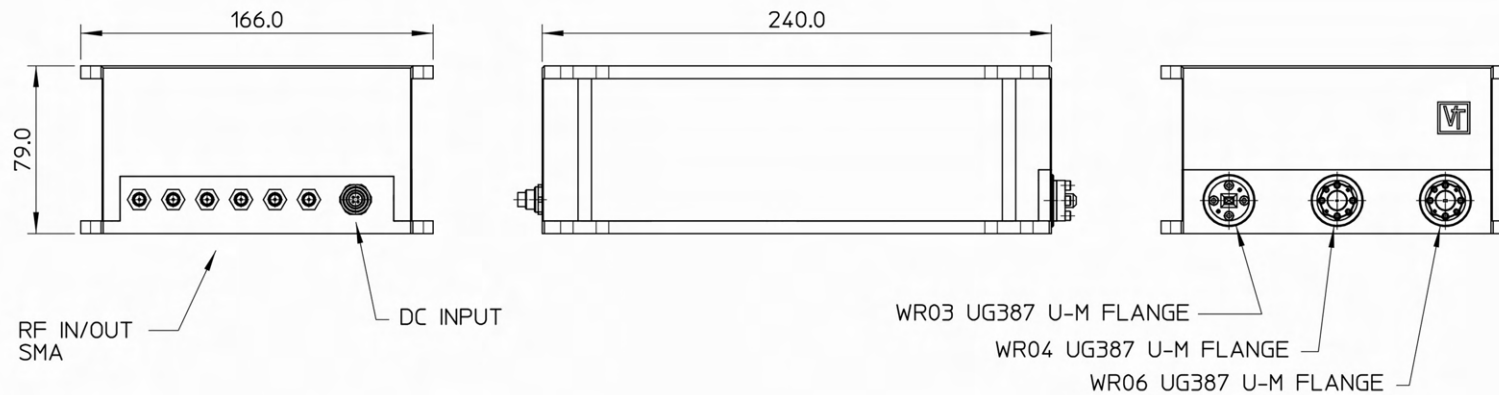

Fig 5 110-330 GHz Converter Module

## Fullband 75-500 GHz Up/Downconverters

### General Features

- Full band coverage from 75-500 GHz
- Broadband output power
- Linear operation
- High sensitivity receivers
- 5G/6G communications research

### Specifications (170-500 GHz)

Model	THZBUC-04	THZBDC-04	THZBUC-03	THZBDC-03	THZBUC-2.2	THZBDC-2.2
<b>FUNCTION</b>	<b>UPCONVERTER</b>	<b>DOWNCONVERTER</b>	<b>UPCONVERTER</b>	<b>DOWNCONVERTER</b>	<b>UPCONVERTER</b>	<b>DOWNCONVERTER</b>
<b>RF Frequency (GHz)</b>	170-260	170-260	220-330	220-330	330-500	330-500
<b>RF Power Output (dBm)</b>	-14 to -20 typical	-	-15 typical	-	-20 to -30 typical	-
<b>RF Input Maximum (dBm)</b>	-	-15	-	-15	-	-15
<b>IF Input Frequency (GHz)</b>	0.1-20	-	0.1-20	-	0.1-20	-
<b>IF Input at saturation (dBm)</b>	-5	-	-5	-	-5	-
<b>IF Output Frequency (GHz)</b>	-	0.1-20	-	0.1-20	-	0.1-20
<b>Conversion Gain, (dB)</b>	20 typical	10 typical	20.0 typical	10.0 typical	20.0 typical	10 typical
<b>Noise Figure (dB), DSB typical</b>	-	12-15	-	12-15	-	15-20
<b>LO Frequency (GHz) @ +13 dBm</b>	14.17-21.67	14.17-21.67	10.83-13.75	10.83-13.75	13.75-20.83	13.75-20.83
<b>LO /IF Connector</b>	2 X SMA/K (F)	2 X SMA/K (F)	2 X SMA/K (F)	2 X SMA/K (F)	2 X SMA/K (F)	2 X SMA/K (F)
<b>RF Connector</b>	WR04, UG387/U-M	WR04, UG387/U-M	WR03, UG387/U-M	WR03, UG387/U-M	WR2.2, UG387/U-M	WR2.2, UG387/U-M

#### Notes

1. Module dimensions 70 x 100 x 180 mm (3 Channel THZBUC and THZBDC) excluding fixings (TBC)
2. Test data: Upconverter - power output and spectrum, downconverter - gain and noise figure
3. DSB operation; SSB options to order
4. Option: internal oscillator with 10 MHz or 100 MHz synchronization
5. Optional: RF input LNA and output PA to customer specifications; consult factory
6. **How to make a request:** choose Model, or state full specifications, required interfaces, email to: [sales@vivatechthz.com](mailto:sales@vivatechthz.com)

## Test Data Models THZBUC/BDC-04 & THZBUC/BDC-03

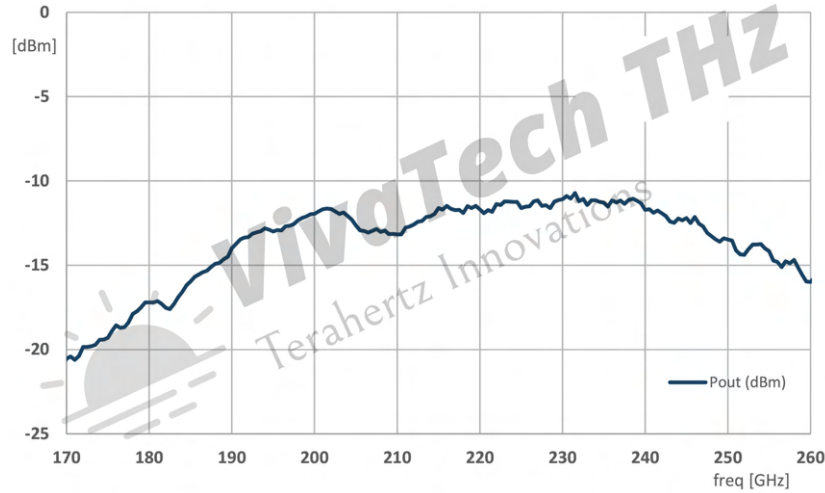

Fig 6 170-260 GHz Upconverter Output Power

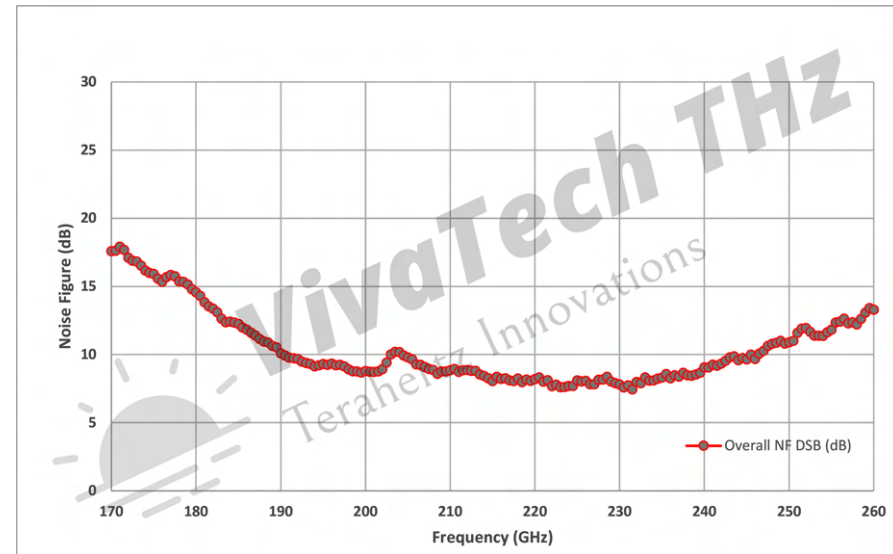

Fig 7 170-260 GHz Downconverter Noise Figure

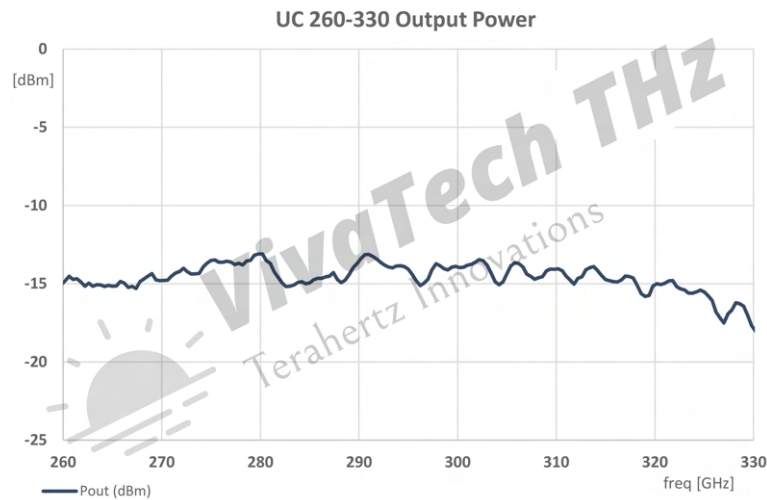

Fig 8 260-330 GHz Upconverter Output Power

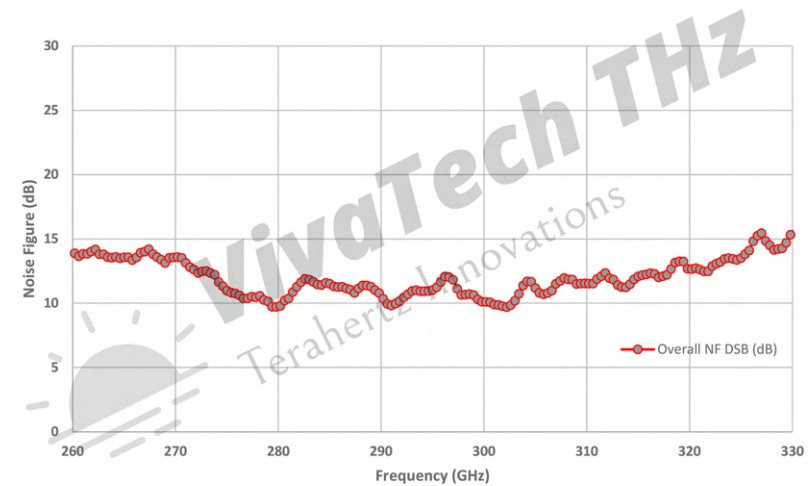

Fig 9 260-330 GHz Downconverter Noise Figure

## 670 GHz Transmitter / Receiver Pair Fieldfox

### General Features

- 650-675 GHz Transmitter / Receiver Converters for automotive FMCW radar
- Extend signal generators/spectrum analyzers or VNA's to mm-wave and THz
- Noise figure 14 dB typical, TX power -10 dBm dynamic range > 100 dB @ 10 Hz IF
- Extend any 20 GHz VNA without direct LO/IF access by linear converters
- Synchronous frequency and swept operation
- Single Sideband (SSB) versions eliminate image response
- Rugged screened enclosures machined from solid



Fig 1 670 GHz Upconverter / Downconverter Pair

### Specifications

Model	THZBUC-1.5NB**	THZBDC-1.5NB**
Input/Output Frequency (GHz)	656-672	656-672
Input/Output RF Frequency (GHz)	4-20	4-20
Input LO Range (GHz)	Internal	Internal
Upconverter Power Output (dBm)	-10 typical	-
Upconverter Gain (dB)	> 10 dB typical	-
Downconverter SSB Noise Figure (dB)	-	< 15.0 typical
Downconverter Conversion Gain, dB	-	10.0 typical
LO /IF Connectors	SMA/K (F)	SMA/K (F)
RF Connector	WR1.5; UG387/U-M	WR1.5; UG387/U-M
Dimensions (mm)	145 x 230 x 60	100 x 200 x 60
DC Power (external PSU)	15V 2A	15V 1.5A

### Notes

1. \*\*Compatible with Signal Generators, Desktop & Portable VNAs up to 40 GHz  
-developed for Keysight Fieldfox 20 GHz portable VNA Model N9918A, N9950A
2. Upconverter / Downconverter pair measures S21 (transmission) phase and amplitude
3. Reference oscillator input 10 MHz or 100 MHz for synchronization to external equipment
4. Other frequency ranges up to 1 THz on request
5. Shown with optional 670 GHz Potter type feedhorn
6. **How to make a request:** choose Model, or state frequency range, required interfaces, email to: [sales@vivatechthz.com](mailto:sales@vivatechthz.com)

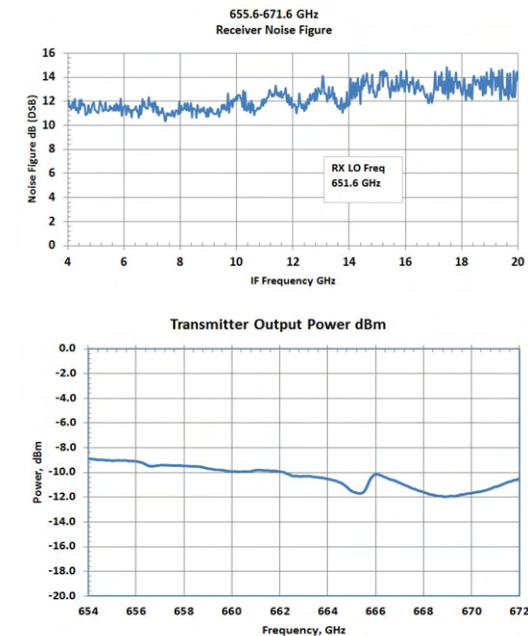

Fig 2 Noise Figure / Output Power

## THz MultiFunction Converter Modules

### General Features

- Extend signal generators/spectrum analyzers or VNA's to mm-wave and THz
- Measure Noise Figure with compatible instruments
- Block Up/Downconverter function with external sources
- Frequency range 75-500 GHz in full-band and narrow band options
- Optional internal local oscillator
- Single Sideband (SSB) versions eliminate image response (Option)
- Rugged screened enclosures machined from solid

### Outline Specifications

Model	THZBDC-06NF/UC	THZBDC-03NF/UC
Input Frequency (GHz)	110-170	220-330
Conversion Loss (dB), SSB typical	< 10.0	< 14.0
Input LO Range (GHz)*	6.875-10.62/13.75-21.25	9.17-14.17/18.33-27.5
IF Range Block Converter Mode (GHz)	> 13.5	> 18
Input 1 dB GCP (dBm)	-5 typical	-5 typical
IF Range S/A Mode	15 KHz to 2 GHz	15 KHz to 2 GHz
RF Input Damage Level (dBm)	> 10	> 10
Operating Temperature (deg C)	20 to 30	20 to 30
LO / IF Connectors	SMA/2.92mm K (F)	SMA/2.92 mm K (F)
RF Connector	WR6.5 ; UG387/U-M	WR3.4 ; UG387/U-M
Dimensions (mm)	200 x 150 x 100	200 x 150 x 100
AC Power Supply (external PSU)	110-240 VAC	110-240 VAC

### Notes

1. Compatible with Spectrum and Signal Analyzers eg. Keysight, R & S etc. DANL -140 dBm (1Hz) typical.
2. Internal or external Local Oscillator, standard level +10 to +13 dBm
3. \*Low LO range spectrum analyzer; high LO range Upconverter / Downconverter mode
4. Dimensions, data, photographs are non-contractual and subject to revision



Fig 1 : Converter Model THZBDC-XX



Fig 2 : Converter (Internal Local Oscillator Option)

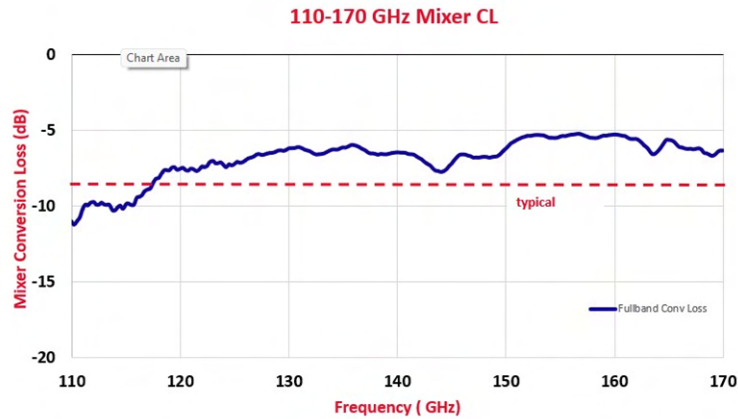

Fig 3 : 110-170 GHz Intrinsic Mixer Conversion Loss (SSB)



Fig 4 : 220-330 GHz Intrinsic Mixer Conversion Loss (SSB)

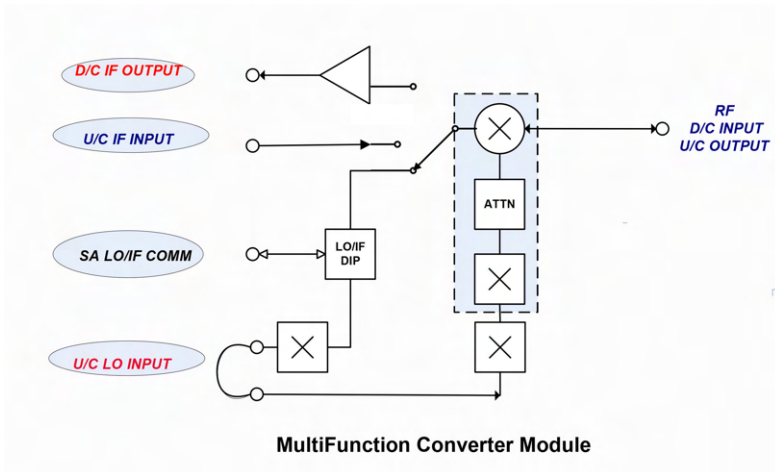

Fig 5 : Functional Schematic

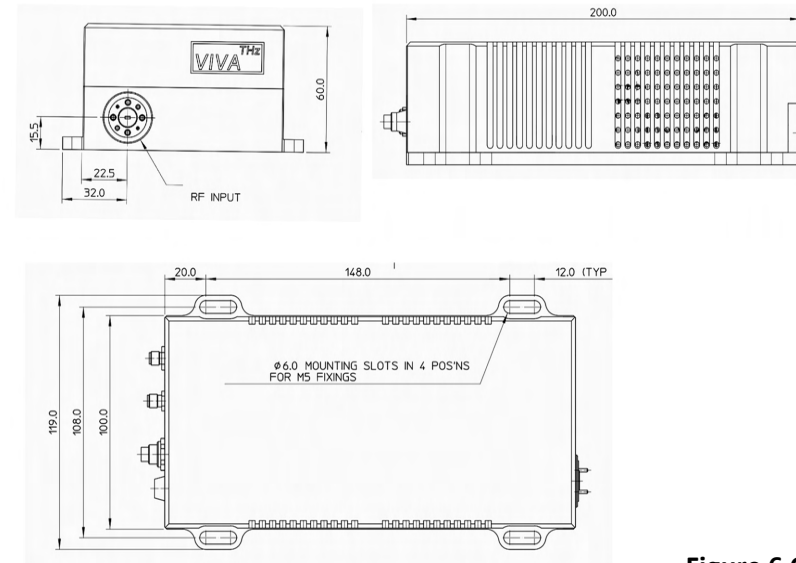

Figure 6 Outline

➤ **How to make a request:** choose Model, or state frequency range, required functions & interfaces, email to: [sales@vivatechthz.com](mailto:sales@vivatechthz.com)

## Source Extender Modules 75-500 GHz

### General Features

- Active multipliers X6, X12, X18, X36
- Coverage: 50 – 500 GHz
- Standard waveguide full-band & narrow-band (higher power)
- Extender for signal generator or VNA
- High output power and flat frequency response
- Option: integrated or external isolators (up to 330 GHz)

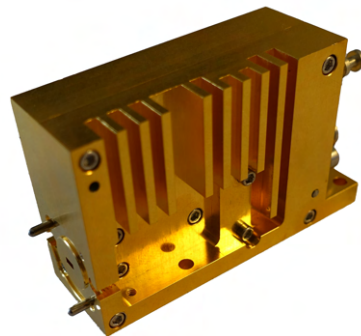

### Specifications

Model	Output Frequency (GHz)	Output Power min, typical (dBm)	Input Frequency (GHz)	Output Waveguide, Flange
THZXFA-10FB	75 – 110	+14, +16	12.50 – 18.33	WR 10, UG387/U-M
THZXFA-08FB	90 – 140	+6 typical	15.00 – 23.30	WR 08, UG387/U-M
THZXFA-06FB	110 – 170	+12, +15	9.17 – 14.17	WR6.5, UG387/U-M
THZXFA-05FB	140 – 220	+4 typical	11.66 – 18.34	WR 05, UG387/U-M
THZXFA-03FB	220 – 330	+3, +5	12.20 – 18.10	WR 03, UG387/U-M
THZXFA-2.2FB	330 – 500	-10, -8	9.02 – 13.89	WR 2.2, UG387/U-M

### Notes

1. RF input power: +7 to +10 dBm
2. Harmonic and spurious: < 20 dBc typical
3. External 110-240 VAC PSU
4. Input connector: SMA/K (F)
5. Option : internal source, internal modulator, external variable attenuator
6. Dimensions : 80 x 135 x 36 mm (TBC)
7. **How to make a request:** specify Model above, or specifications desired; email to: [sales@vivatechthz.com](mailto:sales@vivatechthz.com)



Figure 1 THZXFA-XXFB Source Modules

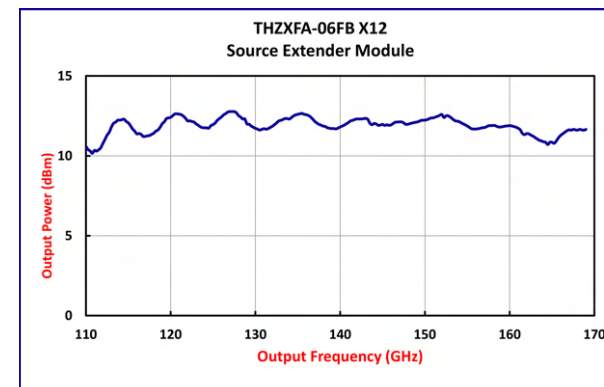

Figure 2 THZXFA-06FB Output Power

## Waveguide Amplifiers - Low Noise

### General Features

- Frequency coverage: 50 – 350 GHz
- Full band and narrow band
- Lowest Available Noise Figure
- High P-1dB
- Low Power Consumption

### Specifications

Model	Frequency (GHz)	Gain (dB), typical	Noise Figure, dB typical	Waveguide	Flange
THZLNA-12FB	60 – 90	15	< 5.0	WR 12	UG 387/U-M
THZLNA-10FB	75 - 110	18	< 3.5	WR 10	UG 387/U-M
THZLNA-10FBH	75 – 110	40	< 3.5	WR 10	UG 387/U-M
THZLNA-06FB	110 - 170	18	< 5.0	WR6.5	UG 387/U-M
<b>THZLNA-06FBH</b>	<b>110 - 170</b>	<b>35</b>	<b>&lt; 5.0</b>	<b>WR6.5</b>	<b>UG 387/U-M</b>
THZLNA-05FB	140 – 220	20	< 7.5 mid band	WR 05	UG 387/U-M
THZLNA-04NB	210 - 260	18	< 7.5	WR 04	UG 387/U-M
THZLNA-03/2.8NB	250 - 350	25	< 12	WR 03/2.8	UG 387/U-M

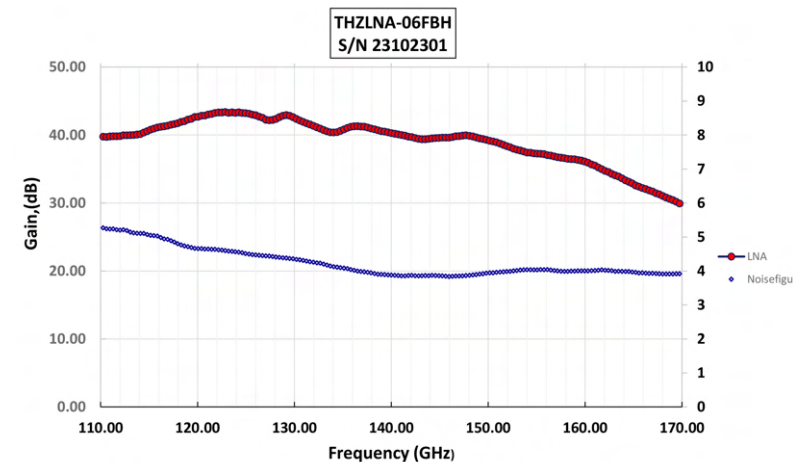

### Notes

1. Test Data: Gain or S parameters, noise figure
2. **How to make a request:** select one of the Models above, or provide specifications to [sales@vivatechthz.com](mailto:sales@vivatechthz.com)



## Waveguide Fundamental Balanced Mixers

### General Features

- Frequency coverage: 50 – 140 GHz
- Waveguide full bandwidth RF/LO as standard
- Zero bias, with LO +10 to +13 dBm
- Low conversion loss
- IF to > 20 GHz

### Specifications

Model	RF /LO Frequency (GHz)	Conversion Loss (dB) <sup>-1</sup>	IF Frequency (GHz) max <sup>-3</sup>	Input RF <sub>MAX</sub> (dBm)	Waveguides, Flange
THZBM-15	50 – 75	7 typical, 10 max	18	13	WR 15, UG385/U
THZBM-12	60 – 90	7 typical, 10 max	18	13	WR 12, UG387/U-M
THZBM-10	75 – 110	7 typical, 10 max	18	13	WR 10, UG387/U-M
THZBM-08	90 – 140	8 typical, 12 max	18	13	WR 08, UG387/U-M

### Notes

1. Conversion loss, LO @ +13 dBm, IF DC - 18 GHz (IF can extend to 35 GHz with increased loss)
2. Option: combined mixer / LO amplifier units with low LO (0 to + 3 dBm typical); send request
3. IF bandwidths typically > 35 GHz with fixed LO. (See also Note 1)
4. IF connector SMA-F/K-F.
5. **How to make a request:** specify Model or waveguide sizes, RF / IF/LO frequency range, LO power, conversion loss, and email to: [sales@vivatechthz.com](mailto:sales@vivatechthz.com)

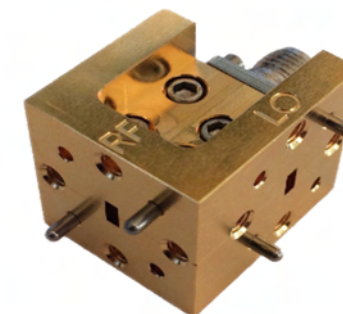

Figure 1 Full Band Fundamental Balanced Mixers

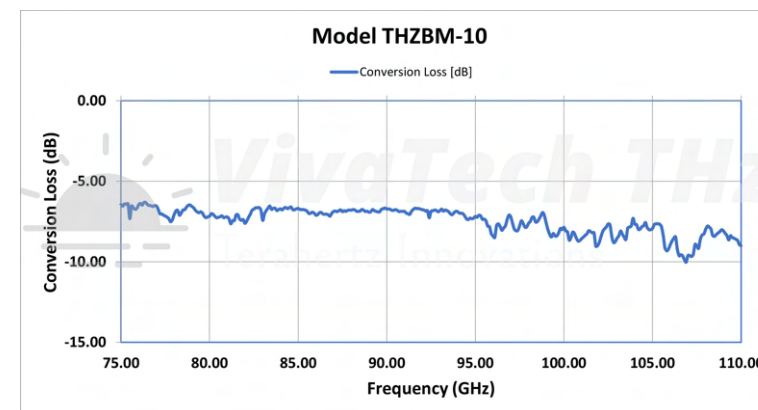

Figure 2 Typical Conversion Loss THZBM-10

## Fullband Subharmonic Mixers

### General Features

- Frequency coverage: 110 - 350 GHz
- Waveguide full bandwidths up to 330 GHz
- Local Oscillator Frequency = ½ RF
- LO Power +7 to +10 dBm
- Low conversion loss
- IF > 20 GHz

### Specifications

Model	RF Frequency (GHz)	LO Frequency (GHz)	Conversion Loss (dB) <sup>-1</sup>	IF Range (GHz) <sup>-3</sup>	RF/LO Waveguide
THZSHM-06	110-170	55-85	10 typical	0.1-20	WR 06/12, UG387/U-M
THZSHM-04	170-260	85-130	10 typical	0.1-20	WR 04/08, UG387/U-M
THZSHM-03	220-330	110-165	12 typical	0.1-20	WR 03/06, UG387/U-M
THZSHM-2.8NB	300-350	160-175	15 typical	0.1-20	WR 2.8/06, UG387/U-M



Figure 1 THZSHM-06 110-170 GHz

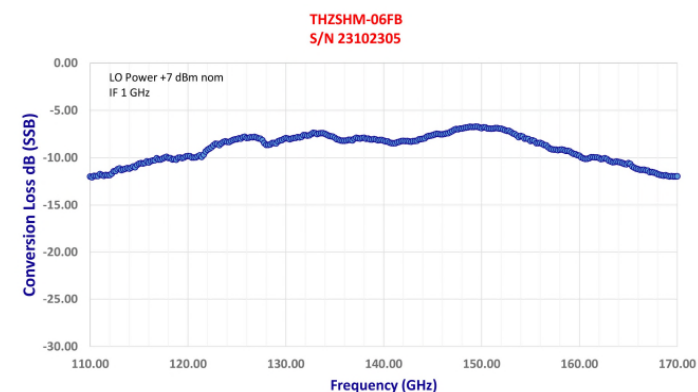

Figure 2 Typical Conversion Loss THZSHM-06

### Notes

1. Conversion loss, DSB, with LO optimized @ +10 dBm typical
2. Option: combined mixer / LO units; send request
3. IF bandwidths > 20 with variable LO. (IF may extend to 35 GHz with fixed LO, send request)
4. IF connector SMA-F/K-F
5. **How to make a request:** specify Model and RF, IF, LO frequency range, LO power, conversion loss, and email to: [sales@vivatechthz.com](mailto:sales@vivatechthz.com)

## Full Band Waveguide Harmonic Mixers

### General Features

- Frequency coverage: 75 – 330 GHz
- Waveguide full bandwidth as standard
- Zero bias, common or separate LO / IF ports
- General purpose frequency extension for Spectrum Analyzers
- Even mixing harmonics

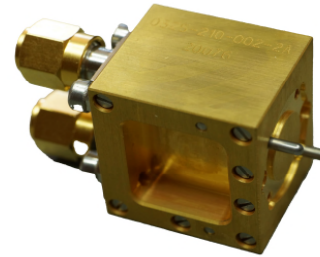
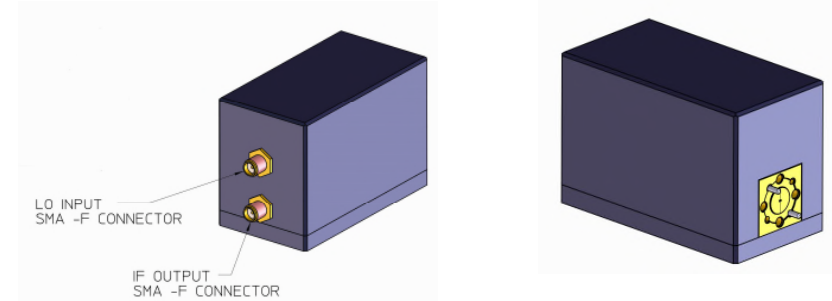

Figure 1 3-port Waveguide Harmonic Mixer



### Specifications

RF Frequency (GHz)	Model	Conversion Loss (dB) <sup>-1</sup>	LO Frequency (GHz) Maximum	RF <sub>MAX</sub> (dBm)	Waveguide
75 – 110	THZW HM-10	20 typical	9.37-13.75	+15	WR 10, UG 387/U-M
<b>75 – 110</b>	<b>THZW HM-10P</b>	<b>20 typical</b>	<b>9.37-13.75</b>	<b>+15</b>	<b>WR 10, UG 387/U-M</b>
90 – 140	THZW HM-08	30 to 35	18	+3	WR 08, UG 387/U-M
110 – 170	THZW HM-06	25 typical, 35 max	20	+3	WR 06, UG 387/U-M
140 – 220	THZW HM-05	35 typical	20	0	WR 05, UG 387/U-M
170 - 260	THZW HM-04	35 to 42	18	0	WR 04, UG 387/U-M
220 – 330	THZW HM-03	35 to 40	18	0	WR 3.4, UG 387/U-M

### Notes

1. Conversion loss, LO range 8 - 20 GHz @ +13 to +17 dBm, IF DC – 3 GHz; value depends on harmonic number
2. **-P low LO power version, LO +5 to + 10 dBm typical, packaged with internal LO amplifier, +12V DC required**
3. LO/IF bandwidths up to 18 GHz. Common or separate LO/IF ports. No DC bias required
4. External isolators are available up to 325 GHz
5. **How to make a request:** specify model or waveguide sizes, RF/IF/LO frequency range, conversion loss, email to: [sales@vivatechthz.com](mailto:sales@vivatechthz.com)

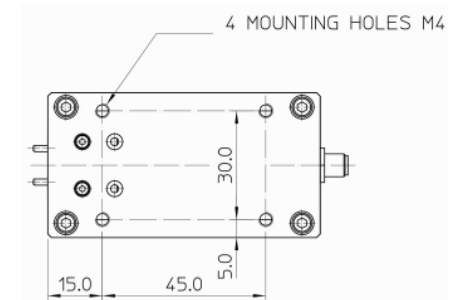

Figure 2 Model THZW HM-10P (DC port not shown)

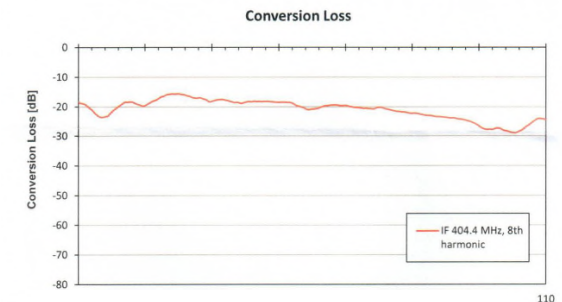

Figure 3 THZW HM-10P Conversion Loss

## 183 GHz Integrated Mixer Amplifier Module

### General Features

- Compact Low Noise Receiver with state-of-art broadband performance
- Broadband DSB (standard) or SSB function (option)
- Radiometer integration, space qualifiable
- External fixed or variable local oscillator
- Optional internal local oscillator
- -20 to + 60 deg temperature range as standard

### Outline Specifications

<b>Model</b>	<b>THZSHM-05IF-183-33</b>
<b>Input Frequency (GHz)*</b>	183 +/- 16.5
<b>Gain (dB), typical, at 25 deg C</b>	35
<b>Noise Figure (dB) @ - 20 to + 60 deg C</b>	8.0 maximum ( < 6 dB typical)
<b>LO Frequency (GHz)*</b>	91.65
<b>LO Power (dBm)</b>	+ 5 to +7 typical
<b>IF Range*</b>	0.5-16.5
<b>Operating Temperature (deg C)</b>	-20 to +60
<b>IF Connector</b>	2.92 mm K (F)
<b>RF Connector</b>	WR 05 ; UG387/U-M
<b>LO Connector</b>	WR 10 ; UG387/U-M
<b>Dimensions (mm)</b>	38 x 19 x 19

### Notes

1. Developed for low noise receiver/radiometer applications
2. Internal or external Local Oscillator, standard level +5 to + 7 dBm
3. \*Other frequencies to order
4. DC +12 V, 150 mA
5. Dimensions, data, photographs are non-contractual and subject to revision

➤ **How to make a request:** choose Model, or state frequency range, required functions & interfaces, email to: [sales@vivatechthz.com](mailto:sales@vivatechthz.com)



**Fig 1 : Mixer Pre-amplifier THZSHM-05IF**

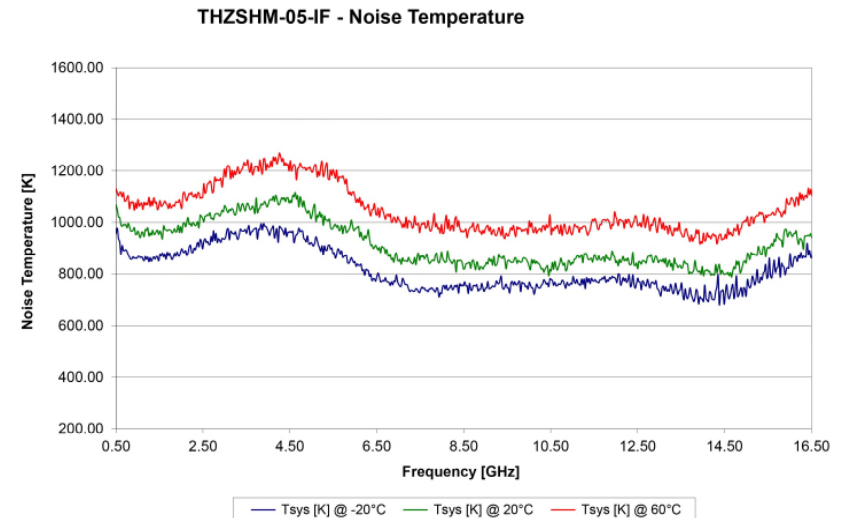
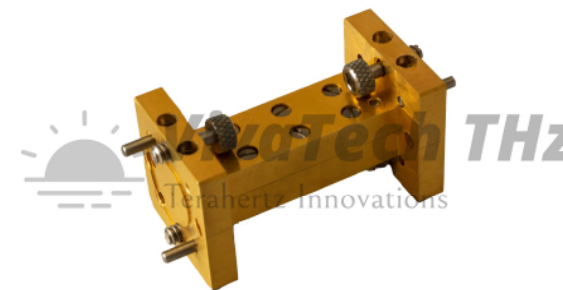

**Fig 2 : Noise Figure 183 GHz Mixer Pre-amplifier**

## Precision Waveguide Straight Sections 75-1100 GHz

### General Features

- Frequency coverage: up to 1.1 THz
- Machined from solid or drawn waveguide\*
- High precision
- Custom length
- Lowest loss in industry



### Specifications

Model	Frequency Range (GHz)	Waveguide Designation	New IEEE Waveguide Designation	Standard Flange <sup>2</sup>
THZWG-10-xx	75 – 110	WR 10	WM-2540	UG 387/U-M
THZWG-08-xx	90 – 140	WR 08	WM-2022	UG 387/U-M
THZWG-06-xx	110 – 170	WR 06	WM-1651	UG 387/U-M
THZWG-05-xx	140 – 220	WR 05	WM-1295	UG 387/U-M
THZWG-04-xx	170 – 260	WR 04	WM-1092	UG 387/U-M
THZWG-03-xx	220 – 330 <sup>-3</sup>	WR 03	WM-864	UG 387/U-M
THZWG-2.8-xx	260 – 400	WR 2.8	WM-710	UG 387/U-M
THZWG-2.2-xx	330 – 500	WR 2.2	WM-570	UG 387/U-M
THZWG-1.5-xx	500 – 750	WR 1.5	WM-380	UG 387/U-M
THZWG-1.0-xx	750 - 1100	WR 1.0	WM-250	UG 387/U-M

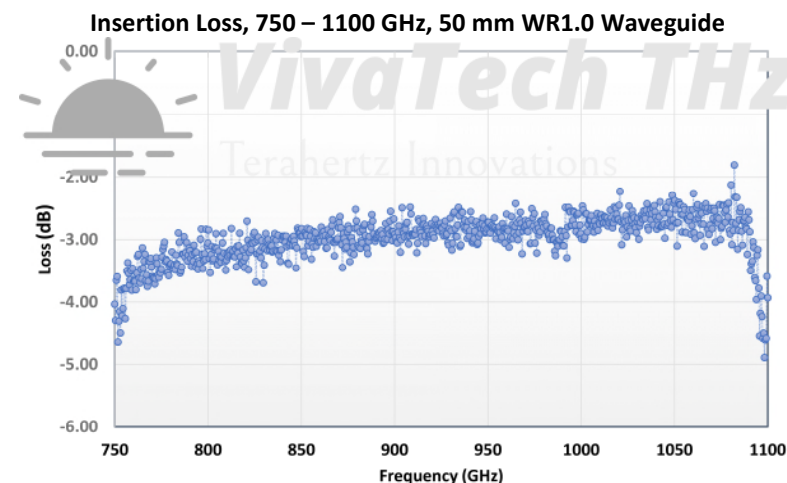

### Notes

1. New definitions are in use above 110 GHz, as defined by IEEE standards up to 1.1 THz.
2. \*Depends on Model. Above 110 GHz most units (see photo) are machined from solid brass and gold plated.
3. There are variations in industry 'standard' flanges. When ordering waveguides > 100 GHz advise required flange PIN and hole dimensions
4. Waveguide WR 03 historically covers 220-325 GHz, whereas the new standard WM-864 extends coverage to 220 – 330 GHz
5. Standard waveguides are 25 mm long and machined in solid brass gold plated, unless otherwise stated. Other lengths and materials available to order.
6. **How to make a request:** specify Model number with required length eg. THZWG-03-50 is a WR03/WM-864 straight section of length 50 mm. Email to: [sales@vivatechthz.com](mailto:sales@vivatechthz.com)

## Precision Waveguide Transitions

### General Features

- Frequency coverage: up to 500 GHz
- Inter-series adapters
- High precision
- Custom length possible
- Low loss
- Robust versions machined from solid



Figure 1 THZWGTA-06-05

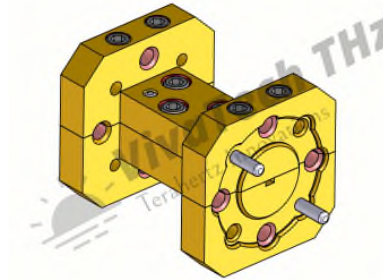

Figure 2 THZWGTA-3.4-2.2

### Specifications

Model Waveguide Transition	Waveguide Port 1	Frequency Coverage (GHz)	Waveguide Port 2	Frequency Coverage (GHz)
THZWGTA-15-12	WR15 UG385/U	50 - 75	WR12 UG387/U-M	60 - 90
THZWGTA-12-10	WR12 UG387/U-M	60 - 90	WR10 UG387/U-M	75 - 110
THZWGTA-10-08	WR10 UG387/U-M	75 - 110	WR08 UG387/U-M	90 - 140
THZWGTA-08-06	WR08 UG387/U-M	90 - 140	WR06 UG387/U-M	110 - 170
THZWGTA-06-05	WR06 UG387/U-M	110 - 170	WR05 UG387/U-M	140 – 220
THZWGTA-05-04	WR05 UG387/U-M	140 - 220	WR04 UG387/U-M	170 – 260
THZWGTA-04-03	WR04 UG387/U-M	170 - 260	WR03 UG387/U-M	220 - 325
THZWGTA-03-2.8	WR03 UG387/U-M	220 - 325	WR2.8 UG387/U-M	260 - 400
THZWGTA-2.8-2.2	WR2.8 UG387/U-M	260 - 400	WR2.2 UG387/U-M	330 - 500

### Notes

1. Model THZWGTA-15-12 is a waveguide transition between waveguide WR15 and WR12.
2. Transitions between series are formed by precision tapers.
3. There are variations in industry 'standard' flanges. Precision flanges have tighter tolerances. Specify your needs.
4. Standard waveguide transitions have a length of 25 mm. Models THZWGTA -15-12 and THZWGTA-12-10 have a length of 36 mm. Dimensions are available to order.
5. **How to make a request:** specify Model number, or custom dimensions if required. Email to: [sales@vivatechthz.com](mailto:sales@vivatechthz.com)

## Precision Waveguide Bends & Twists

### General Features

- Frequency coverage: up to 1100 GHz
- High precision
- Custom length possible
- Low loss
- Robust versions machined from solid

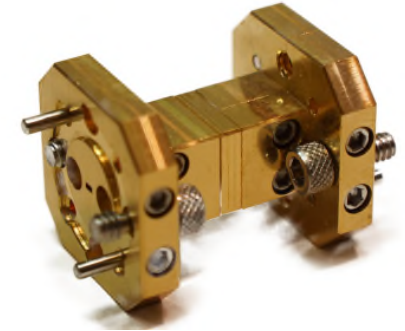
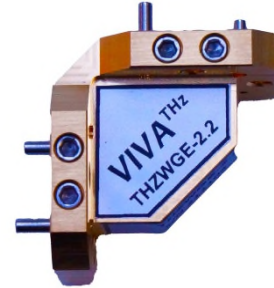

### Specifications

Model E/H Plane 90° Bend	Model Twist 90° ** Note 6	Frequency Coverage (GHz)	Waveguide Designation	New IEEE Waveguide Designation	Standard Flange <sup>-2</sup>
THZWGE/H-10	THZWGTW-10	75 – 110	WR 10	WM-2540	UG 387/U-M
THZWGE/H-08	THZWGTW-08	90 – 140	WR 08	WM-2022	UG 387/U-M
THZWGE/H-06	THZWGTW-06	110 – 170	WR 06	WM-1651	UG 387/U-M
THZWGE/H-05	THZWGTW-05	140 – 220	<b>WR 05</b>	<b>WM-1295</b>	<b>UG 387/U-M</b>
THZWGE/H-04	THZWGTW-04	170 – 260	WR 04	WM-1092	UG 387/U-M
THZWGE/H-03	THZWGTW-03	220 – 330 <sup>-3</sup>	WR 03	WM-864	UG 387/U-M
THZWGE/H-2.8	THZWGTW-2.8	260 – 400	WR 2.8	WM-710	UG 387/U-M Precision
THZWGE/H-2.2	THZWGTW-2.2	330 – 500	WR 2.2	WM-570	UG 387/U-M Precision
THZWGE/H-1.5	THZWGTW-1.5	500 – 750	WR 1.5	WM-380	UG 387/U-M Precision
THZWGE/H-1.0	THZWGTW-1.0	750 – 1100	WR 1.0	WM-250	UG 387/U-M Precision

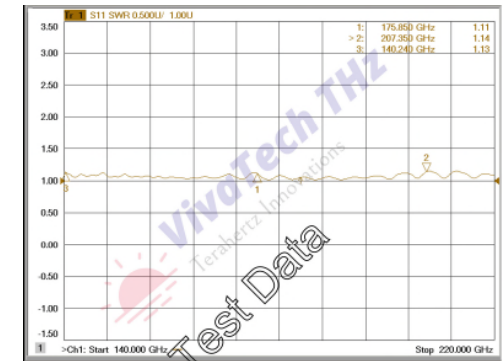

Fig 1 WR5.1 90 deg Twist

### Notes

1. Model THZWGE-XX is an E plane 90 deg Bend. Model THZWGH-XX is the H plane equivalent.
2. New waveguide definitions are now also in use above 75 GHz, as defined by IEEE.
3. There are variations in industry 'standard' flanges. Precision flanges have tighter tolerances. Specify your needs.
4. Waveguide WR 03 historically covers 220-325 GHz. The new standard WM-864 extends coverage to 220 – 330 GHz.
5. Standard waveguides have length 25 mm, bends 25 x 25 mm, twists have length 25 mm.
6. \*\*'Shim 90 deg twists' with 0.2 mm thickness and reduced loss are available to special order.
7. **How to make a request:** specify Model number, or custom dimensions if required. Email to: [sales@vivatechthz.com](mailto:sales@vivatechthz.com)

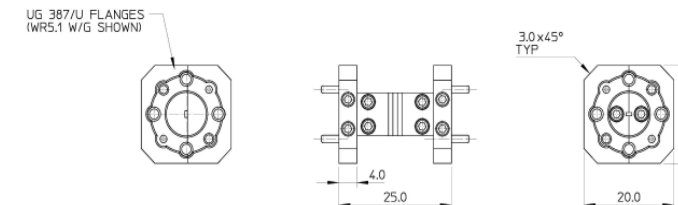

Fig 2 WR5.1 Twist Outline

## Waveguide Couplers - Full Band

### General Features

- Frequency coverage: 50 – 500 GHz
- Full waveguide bands
- Low insertion loss
- 3-port or 4-port models
- Fully Calibrated

W Band 3 port 20 dB Coupler  
Typical Performance

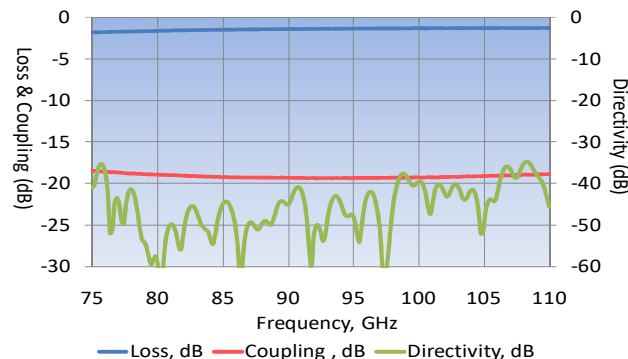

### Specifications

Model	Frequency (GHz)	Insertion Loss, typ (dB)	Directivity (dB); Minimum	Coupling (dB)	Waveguide
THZWGC-15-XX	50 – 75	0.75	35		WR 15, UG 385/U
THZWGC-10-XX	75 – 110	0.9	35		WR 10, UG 387/U-M
THZWGC-08-XX	90 – 140	1.1	30	3 to 40 <sup>-1</sup>	WR 08, UG 387/U-M
THZWGC-06-XX	110 – 170	1.2	25		WR 06, UG387/U-M
THZWGC-05-XX	140 - 220	1.5	25		WR 05, UG387/U-M
THZWGC-04-XX	170 – 260	1.7	25		WR 04, UG387/U-M
THZWGC-03-XX	220 – 325	2.2	25		WR 03, UG387/U-M
THZWGC-2.2-XX	325 - 500	3.5	30 typical		WR 2.2, UG 387/U-M

### Notes

1. Coupling values available (-XX) depend on frequency band selected. Specify required value eg. **THZWGC-10-20** is a **3 port 20 dB coupler for WR10 band**
2. Dual couplers with internal terminations are available upon request in certain frequency ranges
3. **How to make a request:** select one of the Models above, or provide specifications and email to: [sales@vivatechthz.com](mailto:sales@vivatechthz.com)



## Isolators – 50-400 GHz Full Waveguide Bands

### General Features

- Full band coverage
- Compact, low loss
- Lowest insertion loss in industry
- Low VSWR
- High isolation
- Available up to 400 GHz

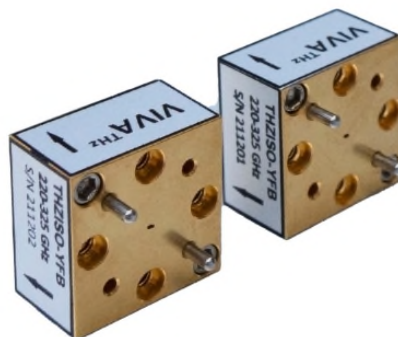

### Specifications

Model	Frequency (GHz)	Insertion Loss (dB); typical, max	Isolation (dB); typical	Waveguide, Flange
THZISO-VFB	50 – 75	1.3	> 20	WR 15, UG 385/U
THZISO-WFB	75 – 110	1.3	> 20	WR 10, UG387/U-M
THZISO-FFB	90 – 140	1.5	> 20	WR 08, UG 387/U-M
THZISO-DFB	110 – 170	0.8, 1.3 max	> 20	WR 06, UG 387/U-M
THZISO-GFB	140 – 220	1.7 typical, 2.3 max	> 20	WR 05, UG 387/U-M
THZISO-43FB	170 – 260	1.7 typical, 3.2 max	> 22	WR4.3, UG 387/U-M
THZISO-YFB	220 - 330	2.3 typical, 3.5 max	> 25	WR 3.4, UG 387/U-M
THZISO-28FB	260 - 400	3.8 typical, 5.6 max	> 25	WR 2.8, UG 387/U-M

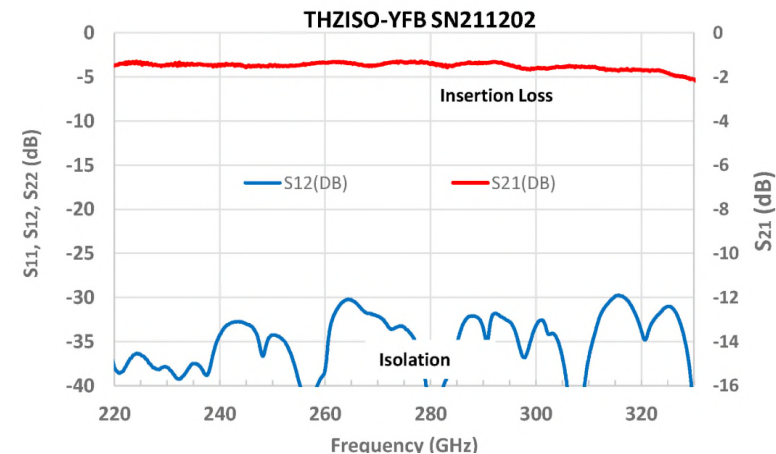

Figure 2 Insertion Loss & Isolation 220-330 GHz

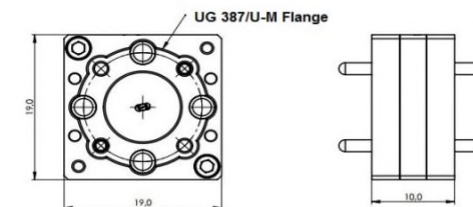

Figure 3 Outline dimensions 19 x 19 x 10 mm

### Notes:

1. How to make a request: Select a model above, or provide required frequency range, insertion loss, isolation, and waveguide size, send email to: [sales@vivatechthz.com](mailto:sales@vivatechthz.com)
2. These compact isolators offer lower loss than conventional designs
3. **How to make a request:** specify Model number. Email to: [sales@vivatechthz.com](mailto:sales@vivatechthz.com)

## Custom Lowpass / Bandpass Filters

### General Features

- Frequency coverage: 50 – 220 GHz
- Waveguide standard bands
- Custom rejection characteristics
- Low passband insertion loss

### Specifications

Model	Frequency Band (GHz)	BW ** typical (%)	Passband* Insertion Loss dB typical	Rejection dB typical *	Waveguide (WR)	Standard Flange
THZLPF/BPF-15	50 – 75	3-15	< 1.5-2.0	30 - 40	WR 15	UG 385/U
THZLPF/BPF-10	75 - 110	3-15	< 2.0-2.5	30 - 40	WR 10	UG 387/U-M
THZLPF/BPF-08	90 - 140	3-15	< 2.0-3.0	30 - 40	WR 08	UG 387/U-M
THZLPF/BPF-06	110 - 170	5-20	< 2.5-3.5	30 - 40	WR 06	UG 387/U-M
THZLPF/BPF-05	140 – 220	5-20	< 2.5-4.5	30 - 40	WR 05	UG 387/U-M
THZLPF/BPF-04	170 – 260	5-20	< 2.5-4.5	30 - 40	WR 04	UG 387/U-M
THZLPF/BPF-03	220 - 330	5-20	< 2.5-4.5	30 - 40	WR 03	UG 387/U-M

#### \*Notes

1. Model THZLPF-XX is a Low Pass Filter and THZBPF-XX is a Band Pass Filter
2. \*\* Other values on request
3. \*Specification dependent. Predicted performance simulations may be available
4. High Pass Filters up to 500 GHz on request - see [Custom High Pass Filters](#)
5. Material: gold plated brass body and flanges
6. **How to make a request**, select one of Models above, provide specifications and email to: [sales@vivatechthz.com](mailto:sales@vivatechthz.com)

\*Subject to review : photo and data non contractual



Figure 1 THZBPF-03 Bandpass Filter

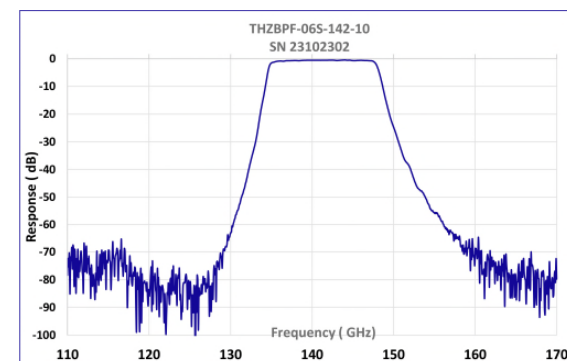

Figure 2 THZBPF-06 135-145 GHz

## Custom High Pass Filters

### General Features

- Frequency coverage: 50 – 220 GHz
- Waveguide standard bands
- Custom rejection characteristics
- Low passband insertion loss

### Specifications

Model	Frequency Band (GHz)	Cut-off Frequency Fc (GHz)	Rejection dB typical @ Fc*0.95	Waveguide (WR)	Standard Flange
THZHPF-15	50 – 75	Specify	> 40	WR 15	UG 385/U
THZHPF-10	75 - 110	--	> 40	WR 10	UG 387/U-M
THZHPF-08	90 - 140	--	> 40	WR 08	UG 387/U-M
THZHPF-06	110 - 170	--	> 40	WR 06	UG 387/U-M
THZHPF-05	140 – 220	--	> 40	WR 05	UG 387/U-M
THZHPF-04	170 – 260	--	> 40	WR 04	UG 387/U-M
THZHPF-03	220 - 330	--	> 40	WR 03	UG 387/U-M

### \*Notes

1. Insertion loss < 2 dB typical
2. Predicted performance simulations available
3. Up to 500 GHz on request
4. Material: gold plated brass body and flanges
5. **How to make a request**, select one of Models above, provide full specifications and email to: [sales@vivatechthz.com](mailto:sales@vivatechthz.com)

\*Subject to review : photo and data non contractual



Figure 1 Waveguide High Pass Filter

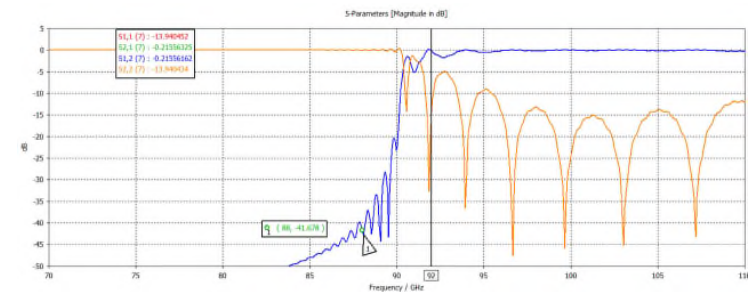

Figure 2 High Pass Filter THZHPF-10 @ 92 GHz

## Antennas - Waveguide Pyramidal Horns

### General Features

- Frequency coverage: 75 – 1100 GHz
- Broadband with full waveguide bandwidth
- Standard gain horns
- Predictable characteristics
- Solid and robust construction



Fig 1 THZAP-1.5RS



Fig 2 THZAP-2.8RS 260-400 GHz

### Specifications

Model	Frequency (GHz)	Gain (dBi), nominal	VSWR, typical	Waveguide, WR	Standard Flange
THZAP-10RS	75 – 110	23.0	< 1.1	WR 10	UG 387/U-M
THZAP-08RS	90 – 140	23.0	< 1.1	WR 08	UG 387/U-M
THZAP-06RS	110 – 170	23.0	< 1.1	WR 06	UG 387/U-M
THZAP-05RS	140 – 220	23.0	< 1.15	WR 05	UG 387/U-M
THZAP-04RS	170 – 260	23.0	< 1.15	WR 04	UG 387/U-M
THZAP-03RS	220 – 325	23.0	< 1.15	WR 03	UG 387/U-M
<b>THZAP-2.8RS</b>	<b>260 – 400</b>	<b>23.0</b>	<b>&lt; 1.5</b>	<b>WR 2.8</b>	<b>UG 387/U-M</b>
THZAP-2.2RS	330 – 500	23.0	< 1.5	WR 2.2	UG 387/U-M
THZAP-1.5RS	500 – 750	23.0	< 1.5	WR 1.5	UG 387/U-M
THZAP-1.0RS	750 - 1100	24.0	< 1.5	WR 1.0	UG 387/U-M

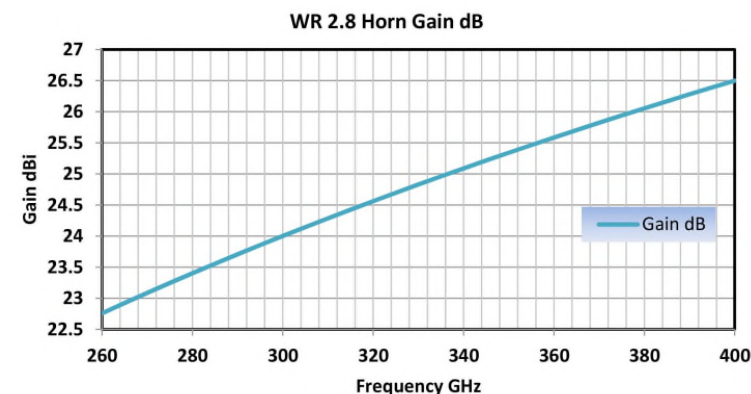

Fig 3 THZAP-2.8RS with 25 dBi gain

### Notes

1. Standard horns have 23 dBi gain at mid band. Other values are available to order. Custom antennas are available.
2. Materials : electroformed copper gold plated and gold plated copper alloy or aluminium.
3. VSWR and gain are typical values from sample product, not tested for each individual horn.
4. *Product photographs and data are non contractual and subject to review.*
5. **How to make a request**, select one of Models above, or provide specifications to: [sales@vivatechthz.com](mailto:sales@vivatechthz.com)

## Antennas - Waveguide Diagonal Horn Antennas

### General Features

- Frequency coverage: 220 – 1100 GHz
- Broadband with full waveguide bandwidth
- Near Gaussian characteristics
- Predictable characteristics
- Solid and robust construction
- Simplified manufacturing



Fig 1 500-750 GHz Diagonal Horn Model THZAP-1.5DS

### Specifications

Model	Frequency (GHz)	Gain (dB) *	HPBW, typical	Waveguide	Flange, anti-cocking type
THZAP-05DS	140 – 220	25.0	8 deg	WR 05	UG 387/U-M
THZAP-04DS	170 – 260	25.0	8 deg	WR 04	UG 387/U-M
THZAP-03DS	225 – 325	25.0	8 deg	WR 03	UG 387/U-M
THZAP-2.8DS	260 – 400	25.0	8 deg	WR 2.8	UG 387/U-M
THZAP-2.2DS	330 – 500	25.0	8 deg	WR 2.2	UG 387/U-M
THZAP-1.5DS	<b>500 – 750</b>	<b>25.0</b>	<b>8 deg</b>	<b>WR 1.5</b>	<b>UG 387/U-M</b>
THZAP-1.0DS	750 - 1100	25.0	8 deg	WR 1.0	UG 387/U-M

### Notes

1. Diagonal horns have antenna patterns close to Gaussian beams and are easier to manufacture than corrugated or conical horns.
2. \*Standard diagonal horns have 25 dBi gain at mid band. Other gains are available to order.
3. Flange types above 110 GHz (WR10) may vary. Specify your flange requirement above WR10.
4. These models are machined from solid Aluminium.
5. *Product photographs and data are non contractual and subject to review.*
6. **How to make a request**, select one of Models above, or provide specifications to: [sales@vivatechthz.com](mailto:sales@vivatechthz.com)

## Antennas - Lens Horn Antennas

### General Features

- Frequency coverage: 110 – 500 GHz
- Pencil beam and asymmetric beams
- Radar & Passive Imaging
- OTA Communications
- Custom Designs

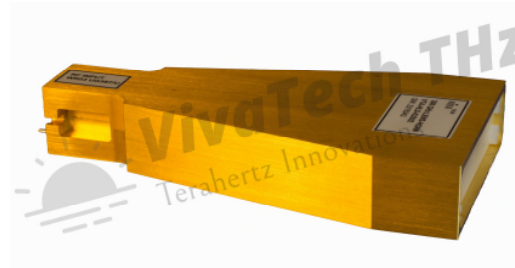
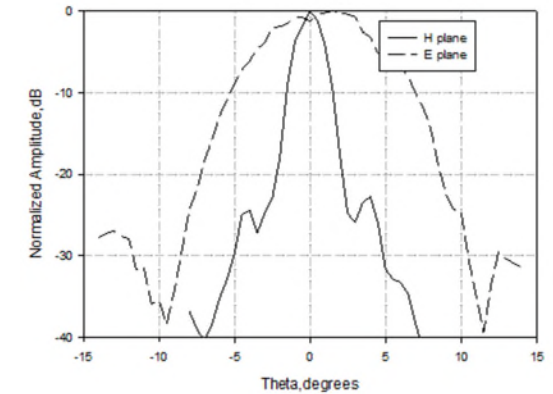

Fig 1 THZHLA-03AB Asymmetric Beam



### Specifications

Model	Frequency (GHz)	Type	Gain (dB)	Beamwidth (E/H) deg <sup>1</sup>	Waveguide, Flange
THZHLA-10NB	75 - 110	Pencil beam	>25 typical	1-5	WR10, UG387/U-M
THZHLA-10AB	75 – 110	Assymetric	custom	1-5, 10-20	WR10, UG387/U-M
THZHLA-06NB	110 - 170	Pencil beam	>25 typical	1-5	WR06, UG387/U-M
THZHLA-06AB	110 – 170	Assymetric	custom	1-5, 10-20	WR06, UG387/U-M
THZHLA-05NB	140 – 220	Pencil beam	>25 typical	1-5	WR05, UG387/U-M
THZHLA-05AB	140 – 220	Assymetric	custom	1-5, 10-20	WR05, UG387/U-M
THZHLA-03NB	220 – 325	Pencil beam	>25 typical	1-5	WR03, UG387/U-M
THZHLA-03AB	220 - 325	Assymetric	custom	1-5, 10-20	WR03, UG387/U-M



Fig 2 THZHLA-03NB Pencil Beam

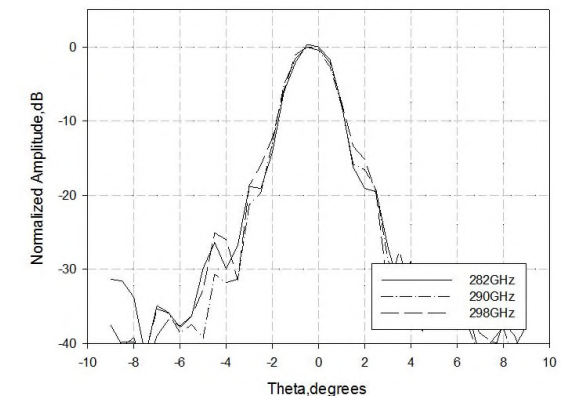

### Notes

1. Nominal, mid band, varies with frequency. Other values are available to order.
2. Flange types above 110 GHz (WR10) may vary. Specify your flange requirement above WR10.
3. Other frequency ranges are available to order.
4. Material is copper or copper alloy gold plated, excluding lens.
5. **How to make a request:** Specify center frequency, 3 dB E/H beam width, waveguide size, gain, any other requirements, email to: [sales@vivatechthz.com](mailto:sales@vivatechthz.com)

## Near Field Probes – Millimeter / THz

### General Features

- Frequency coverage: 75 – 1100 GHz
- Near Field Scanning Applications
- Standard waveguide interfaces
- Quasi-uniform main beam
- Precision machining
- Custom designs

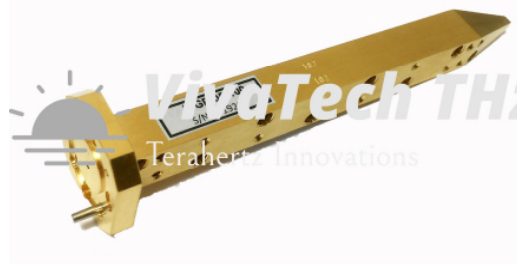

Fig 1 THZWGP-05-100 140-220 GHz

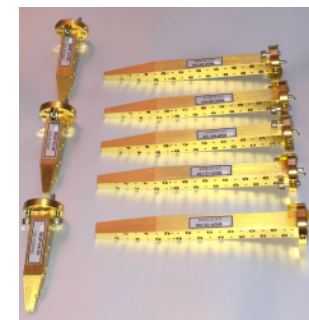

Fig 2 Probe Set 50-500 GHz

### Specifications

Model	Frequency (GHz)	Standard Length, mm	VSWR, typical	Waveguide
THZWGP-10-XX	75 – 110	100.0	< 1.1	WR 10
THZWGP-08XX	90 – 140	100.0	< 1.1	WR 08
THZWGP-06XX	110 – 170	100.0	< 1.2	WR 06
<b>THZWGP-05XX</b>	<b>140 – 220</b>	<b>50.0</b>	<b>&lt; 1.2</b>	<b>WR 05</b>
THZWGP-04XX	170 – 260	50.0	< 1.25	WR 04
<b>THZWGP-03XX</b>	<b>220 – 325</b>	<b>50.0</b>	<b>&lt; 1.5</b>	<b>WR 03</b>
THZWGP-2.8XX	260 – 400	35.0	< 1.5	WR 2.8
THZWGP-2.2XX	330 – 500	35.0	< 1.75	WR 2.2
THZWGP-1.5XX	500 – 750	35.0	< 1.75	WR 1.5
THZWGP-1.0RS	750 - 1100	25.0	< 1.75	WR 1.0

### Notes

1. Suffix – XX denotes length. Standard lengths are shown above. Custom lengths are available.
2. Precision anti-cocking flanges type UG387/U-M are fitted as standard.
3. Probe material is copper or copper alloy gold plated.
4. Probes are tapered to reduce reflections in near field antenna measurements.
5. The chosen length is a compromise between probe loss and potential perturbation of the measurement.

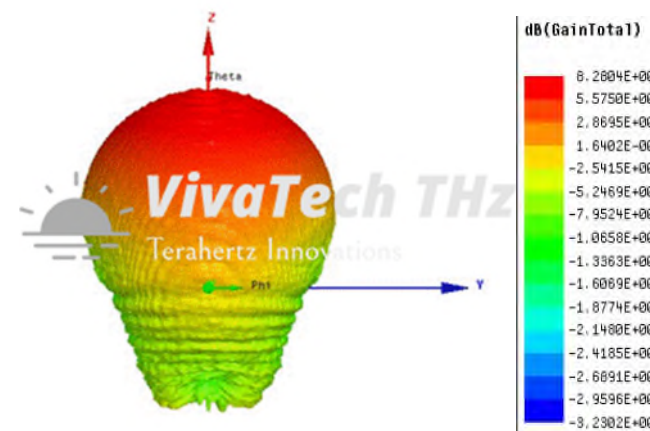

Beam Pattern THZWGP-03-50

## Millimeter Wave Noise Sources -Series THZNS-XXFB

### General Features

- Full band coverage from 110-170 GHz
- Compatible with standard noise figure meters\*
- Use with Noise Test Set Downconverters\*\*
- Integrated Isolator
- High ENR with flat response
- Provided with calibration data
- Automatic noise measurements in mm-wave bands

### Specifications

Model	Frequency Range (GHz)	Noise Source ENR (dB) typical	VSWR	Waveguide Interface
THZNS-19FB	40 - 60	12 +/- 2.5	1.5: 1 max	WR 19, UG387/U-M
THZNS-15FB	50 - 75	12 +/- 2.5	1.5: 1 max	WR 15, UG387/U-M
THZNS-12FB	75 - 110	12 +/- 2.5	1.5: 1 max	WR 12, UG387/U-M
THZNS-10FB	90 - 140	12 +/- 2.5	1.5: 1 max	WR 10, UG387/U-M
THZNS-08FB	140 - 220	12 +/- 2.5	1.5: 1 max	WR 08, UG387/U-M
THZNS-06FB	110 - 170	12 +/- 2.5	1.5: 1 max	WR 06, UG387/U-M

### Notes

- 1.\*Keysight N8975A/B and others
2. Trigger voltage; TTL 1 KHz max
3. DC power; +18 to 28 V < 100 mA typical
4. Stability 0.01 dB/deg C
5. Noise Source is supplied with isolator and calibration data
6. Operating Range 0-30 deg C. Specifications apply at 25 deg C
7. \*\*Details on request



Figure 1. 110-170 GHz Noise Source with Isolator

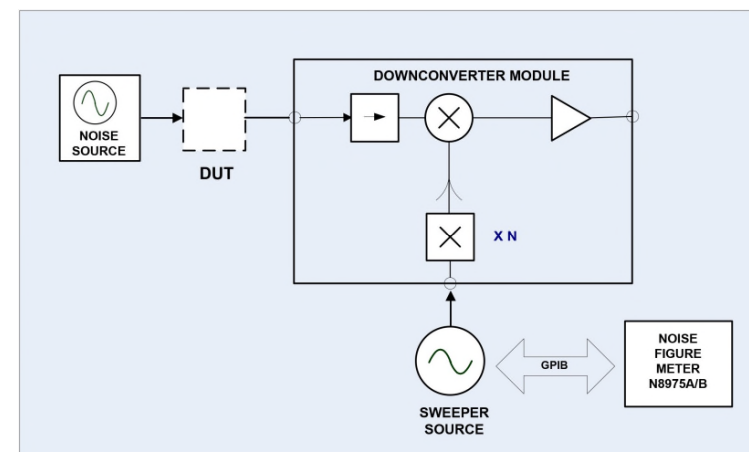

\*\*Figure 2. Noise Test Set Measurement System - Example



## Noise Figure Downconverters - Series THZBDC-XXFBE

### General Features

- Full band coverage from 40-170 GHz in waveguide bands
- Compatible with noise figure meters and spectrum analyzers\*
- Swept frequency measurement
- Compatible solid state noise source provided
- Use with internal spectrum analyzer signal generator\*\*
- Extend noise measurements to mm-wave bands



### Specifications

Model	Frequency Range (GHz)	LO Input Freq (GHz)	Noise Source ENR (dB) typical	Test Range, NF / Gain (dB)	Waveguide Interfaces
THZBDC-19FBE	40 - 60	10.0-15.0	13 +/- 1.5	Noise Figure: 0-20 Gain: -20 to +30	WR 19, UG383/U-M
THZBDC-15FBE	50 - 75	8.33-12.5	13 +/- 1.5		WR 15, UG385/U
THZBDC-12FBE	60 - 90	10.0-15.0	13 +/- 1.5		WR 12, UG387/U-M
THZBDC-10FBE	75 - 110	9.37-13.75	12 +/- 1.5		WR 10, UG387/U-M
THZBDC-08FBE	90-140	7.5-11.67	12 +/- 1.5		WR 08, UG387/U-M
THZBDC-06FBE	110-170	9.17-14.17	12 +/- 2.5		WR 06, UG387/U-M

### Notes

- 1.\*Keysight N8975A/B Noise Figure Meter, various R & S or Keysight Spectrum Analyzers\*\*
2. LO/IF connectors SMA-F
3. IF output 10 MHz - 3 GHz
4. Overall gain 30 dB typical, NF 10 – 15 dB typical
5. DC power: +12 V < 1 A typical (TBC)
6. Noise Source supplied with isolator and calibration data
7. Converter Module 67 x 99 X 180 mm (TBC)

Figure 1. Downconverter Module with Noise Source

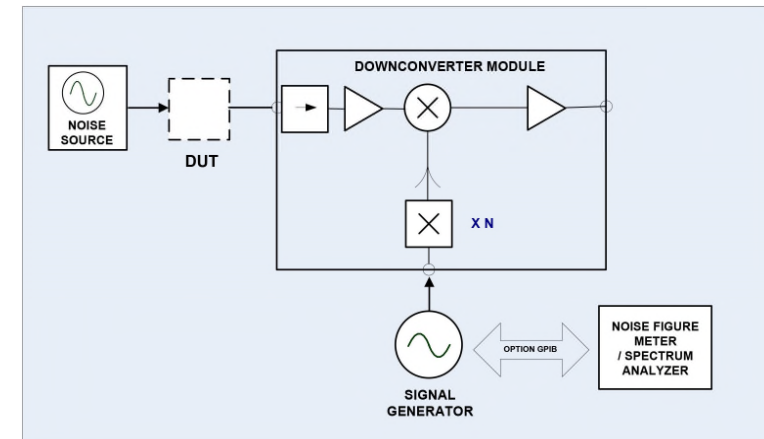

Figure 2. Noise Test Set Measurement System

## Cryogenic Primary Noise Standard 18-500 GHz

VivaTech THz's Cryogenic Noise Standard is a noise source with primary reference performance. Providing precision calibration of low noise components such as amplifiers, diode noise sources or receiver systems, it offers the ultimate in performance. The unique design covers 18 to 500 GHz in standard waveguide bands, incorporating replaceable waveguide assemblies. The standard is particularly suited to mm and sub-mm wave [THz] low noise measurement applications.

### General Features

- Side entry design with convenient connections to waveguide systems
- Vertical or horizontal waveguide orientation – no mismatched bends or twists required
- Low maintenance, compact temperature stabilization system – no water cooling
- Interchangeable waveguide feed-horn assemblies provide mm to sub-mm wave [THz] coverage
- Automatic or manual LN2 filling-auto fill minimizes LN2 use and allows continuous operation
- Fully automated operation with integrated PC
- Real time noise temperature display at any frequency with full data logging

### Specifications

Cryostat Model	Frequency (GHz)	Feed-horn Assembly	Effective Noise Temperature (K) <sup>-1</sup>	Accuracy, deg K	Waveguide
THZPN-18-110	18 – 26	THZA-42-NS	74.75	-0.34 / +0.35	WR 42, UG 595/U
THZPN-18-110	26 – 40	THZA-28-NS	75.54	-0.34 / +0.35	WR 28, UG 599/U
THZPN-18-110	50 – 75	THZA-15-NS	76.67	-0.54 / +0.55	WR 15, UG 385/U
<b>THZPN-18-110</b>	<b>75 – 110</b>	<b>THZA-10-NS</b>	<b>76.02</b>	<b>-0.59 / +0.50</b>	<b>WR 10, UG 387/U-M</b>
THZPN-110-500-FS	90 – 140	THZA-8-NS	76.00	-0.54 / +0.54	WR 08, UG 387/U-M
THZPN-110-500-FS	110 – 170	THZA-6-NS	75.01	-0.59 / +0.60	WR 06, UG 387/U-M
THZPN-110-500-FS	140 – 220	THZA-5-NS	74.56	-0.59 / +0.60	WR 05, UG 387/U-M
THZPN-110-500-FS	220 – 275	THZA-3.4FA-NS	74.20	-1.16 / +1.20	WR 3.4, UG 387/U-M
THZPN-110-500-FS	275 – 325	THZA-3.4FB-NS	73.08	-1.16 / +1.20	WR 3.4, UG 387/U-M
THZPN-110-500-FS	325 – 400	THZA-2.2FA-NS	72.27	-1.46 / +1.55	WR 2.2, UG 387/U-M
THZPN-110-500-FS	400 – 500	THZA-2.2FB-NS	70.44	-1.46 / +1.54	WR 2.2, UG 387/U-M

### Notes

1. Average mid band noise temperature
2. Auto fill option adds a 35 litre LN2 dewar and an automatic LN2 dispenser
3. **How to make a request:** Indicate the cryostat and feed-horn assembly (s) required; Specify manual or automatic liquid nitrogen filling.
4. Email to: [sales@vivatechthz.com](mailto:sales@vivatechthz.com)

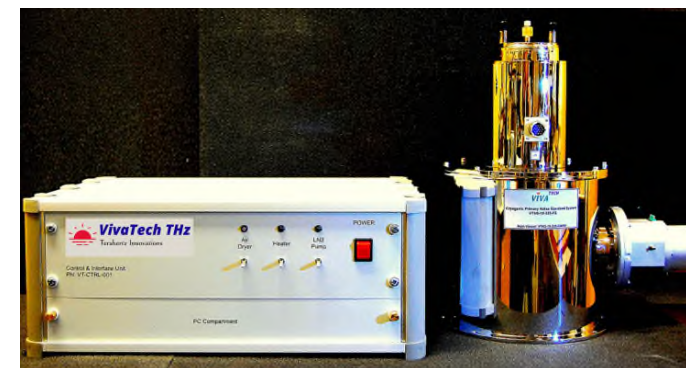

Fig 1 Noise Standard Cryostat with Controller

Fig 2 Output Temperature Display

